



Efficient installations

Bistable Switches BI2xx (DC coil) and Accessories

Bistable switch BI2xx (DC coil)

INTENDED USE

- Residential buildings
- Business premises
- Hotels
- Shopping centres
- Production halls
- Warehouses
- Public places

SWITCHING

- Lighting
- Electric heating
- Electric motors
- Electric equipment

OPERATION

- Impulse control
- Manual control

OTHER BENEFITS

- No hold coil consumption
- Wide application
- Mounting on rail 35 mm rail
- Sealing terminal covers
- Disconnection of remote control by selector switch for maintenance operation

Technical data

| Type | | | BI220 | BI225 | BI232 |
|---|------------------|-------|-----------------------------|-------|-------|
| Standards | | | IEC/EN 60669-2-2 | | |
| Manual control | | | YES | | |
| Control with impulse voltage | | | YES | | |
| Position indicator | | | With actuator | | |
| Pollution degree acc. to IEC/EN 60529 | | | IP20 | | |
| Module width (1 module = 17.5 mm) | | | 1 | | |
| Ambient temperature | | °C | -25 ... +55 | | |
| Storage temperature | | °C | -30 ... +80 | | |
| Max. resistance to humidity | | | 95 % RH at +55 °C | | |
| Min. contact reliability | | | 10 V / 100 mA | | |
| Max. shock resistance acc. IEC/EN 60068-2-27 | | g | 10 | | |
| Max. vibration resistance acc. to IEC/EN 60068-2-6 | | g | 2 | | |
| Min. distance of open contacts | | mm | >3 | | |
| Distance between contacts and coil | | mm | >6 | | |
| Mechanical endurance | | cycle | 10 ⁶ | | |
| Max. back-up fuse for short-circuit protection (gL) | | A | 20 | 25 | 32 |
| Power dissipation per pole | | W | 1.5 | 2 | 3 |
| Rated control voltages | U _c | V | DC: 12, 24, 48, 110, 220 | | |
| Range of control voltage | U _c | % | 90 ... 110 | | |
| Coil consumption - inrush/hold | | W | 9/9 | | |
| Min. impulse duration at U _c | | ms | 100 | | |
| Min. duration between two impulses | | ms | 500 | | |
| Max. number of impulses per minute with min. impulse duration | | | 15 | 7.5 | 7.5 |
| Max. impulse duration | | W | 1 minute + 15 minutes pause | | |
| Rated impulse voltage | U _{imp} | kV | 4 | | |
| Thermal current | I _{th} | A | 20 | 25 | 32 |
| Rated insulation voltage | U _i | V | 440 | | |

Bistable switch BI2xx (DC coil)

Technical data

| Type | | | BI220 | BI225 | BI232 |
|---|-------|-----------------|---------------------------|--------------------|--------------------|
| Rated operational voltage | U_e | V | 440 | | |
| Rated frequency | f_e | Hz | 50 / 60 | | |
| Rated operational current for $\cos \phi = 0.6$ acc. to IEC/EN 60669-2-2 | I_e | A | 20 / 440 V | 25 / 440 V | 32 / 440 V |
| Rated operational current for AC-1 acc. to IEC/EN 60947-4-1 Non-inductive or slightly inductive loads, resistance furnaces | I_e | A | 20 / 440 V | 25 / 440 V | 32 / 440 V |
| Rated operational current for AC-7a acc. to IEC/EN 61095 Slightly inductive loads in appliances and similar applications | I_e | A | 20 / 440 V | 25 / 440 V | 32 / 440 V |
| Rated operational current for DC-1 acc. to IEC/EN 60947-4-1 Non-inductive or slightly inductive loads, resistance furnaces | I_e | A | 20 / 24 V / 1 pole | 25 / 24 V / 1 pole | 32 / 24 V / 1 pole |
| Rated operational current for DC-21 acc. to IEC/EN 60947-3 Switching of resistive loads including moderate overloads | I_e | A | 20 / 24 V / 1 pole | 25 / 24 V / 1 pole | 32 / 24 V / 1 pole |
| Rated operational current for AC-5a acc. to IEC/EN 60947-4-1 Switching of electric discharge lamp controls | I_e | A | 16 / 230 V | | |
| Rated operational current for AC-5b acc. to IEC/EN 60947-4-1 Switching of incandescent lamps | I_e | A | 10 | 10 12 (note 1) | 10 14 (note 2) |
| Rated operational current for fluorescent lamps acc. to IEC/EN 60669-2-2 | I_e | A | 16 / 230 V | | |
| Fluorescent-energy saving/ compact lamps with electronic control gear | I_e | A | 2 / 230 V | | |
| Electrical endurance - for all utilization categories | | cycle | 100.000 | | |
| Terminal capacity for main circuit | S | mm ² | 1 ... 10 rigid / flexible | | |
| Screw for main circuit | | | M4 | | |
| Screw-head for main circuit | | | (±) PZ2 | | |
| Tightening torque for main circuit | | Nm | 1.2 | | |
| Terminal capacity for control circuit | S | mm ² | 1 ... 4 rigid / flexible | | |
| Screw for control circuit | | | M3 | | |
| Screw-head for control circuit | | | (±) PZ1 | | |
| Tightening torque for control circuit | | Nm | 0.6 | | |

Note 1: Corresponding electrical endurance is 60.000 cycles

Note 2: Corresponding electrical endurance is 40.000 cycles

Ordering data

Example: BI220-10 24 V DC

BI220 Type

10 Version of contacts

24 V DC Control voltage (DC)

Bistable switch BI2xx (DC coil)

Contact arrangements

BI220-10, BI225-10, BI232-10

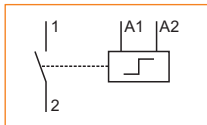

BI220-20, BI225-20, BI232-20

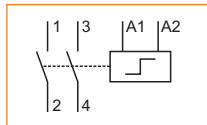

BI220-11, BI225-11, BI232-11

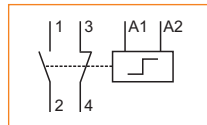

BI220-1C, BI225-1C, BI232-1C

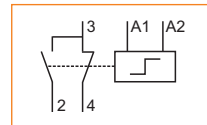

Dimensions

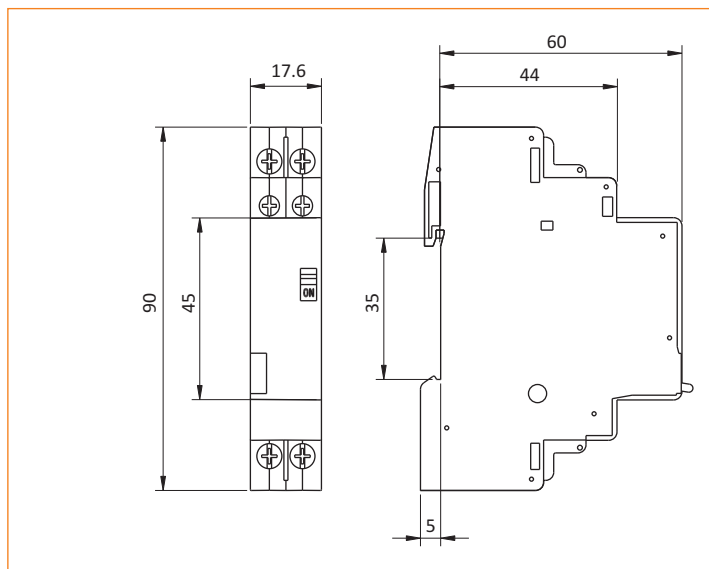

Operation position

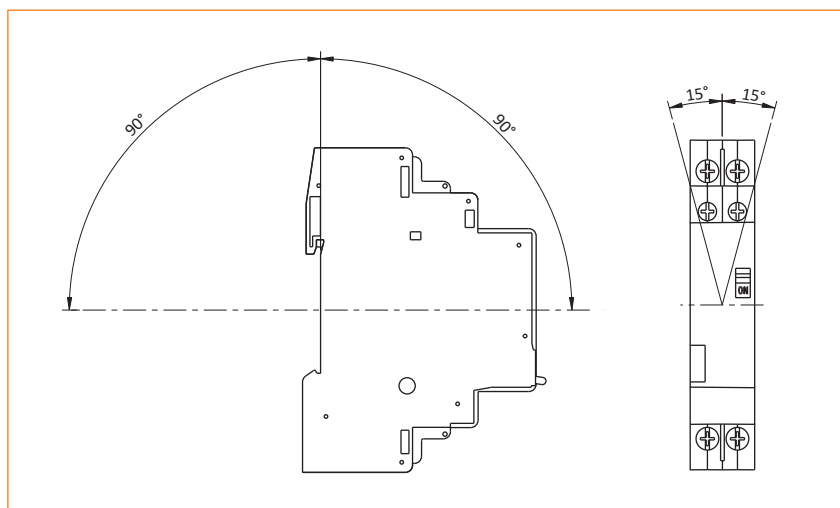

Auxiliary devices for bistable switches

BIN Auxiliary switch

- Reliable switching
- Allows remote indication
- Different version of contacts
- Compatible with the entire range of bistable switches
- Easy to fit on right side of the bistable switch

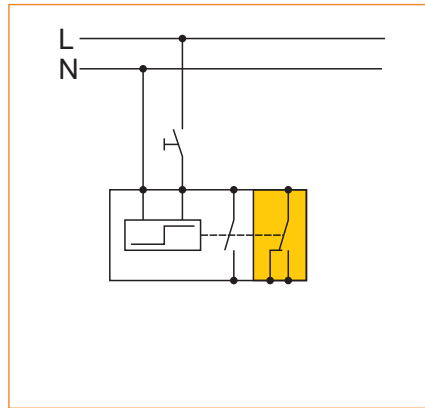

BIC Auxiliary device for centralised control

- For centralised control
- Control by a single command
- Possible to actuate over a time switch
- Each bistable switch with BIC may be independent of local push-button controlled via remote push-buttons ON and OFF
- Compatible with the entire range of bistable switches
- Easy to fit on right side of the bistable switch
- Simple and strong fixing with screw

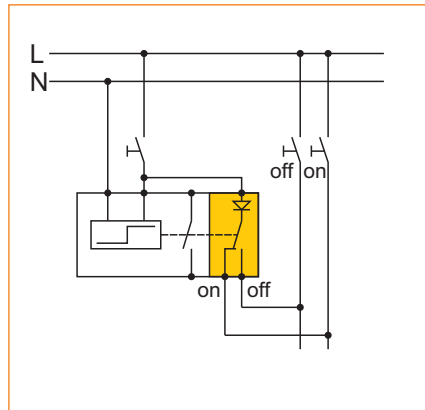

BIG Auxiliary device for group control

- For group control
- Saving space construction
- Quick assembly to 35 mm wide mounting rail

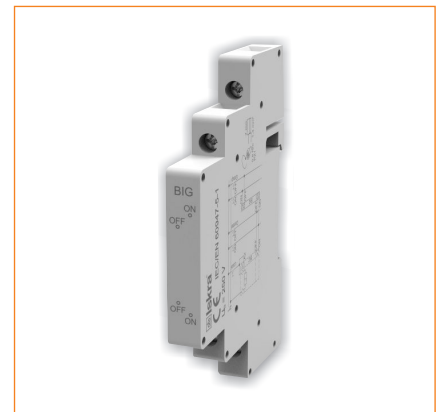
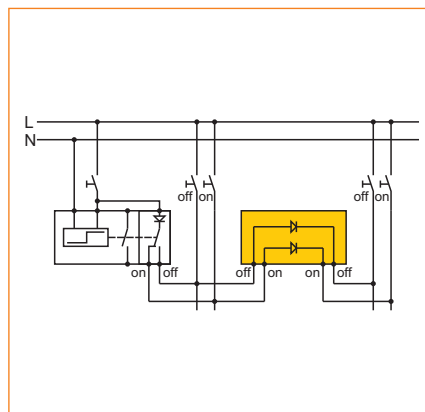

BIK Compensation capacitor

- Increase the number of illuminated push-buttons
- After the installation is not visible from the cabinet
- Independent unit

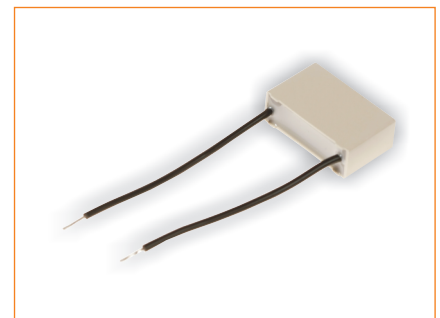

Auxiliary devices for bistable switches

Technical data

| Type | | | BIN | BIC | BIG |
|---|----------|-----------------|---------|--------------------------|-----------|
| Standard | | | | IEC/EN 60947-5-1 | |
| Degree of protection | | | | IP 20 | |
| Module width | | | | 1/2 (9 mm) | |
| Ambient temperature | | °C | | -25 ... +55 | |
| Storage temperature | | °C | | -30 ... +80 | |
| Min. contact reliability | | | | 12 V / 5 mA | - |
| Min. distance of open contacts | | mm | | >3 | - |
| Mechanical endurance | | cycles | | 1.000.000 | - |
| Max. back-up fuse (gL, gG) | | A | 6 | | - |
| Power dissipation per pole | | W | 0.3 | | - |
| Thermal current | I_{th} | A | 6 | | - |
| Rated insulation voltage | U_i | V | | 250 | |
| Rated operational voltage | U_e | V | | 250 | |
| Rated frequency | f_e | Hz | | 50 / 60 | |
| Rated operational current for $\cos \phi = 0.6$ | I_e | A | 6 | | - |
| Rated operational current for AC-21 | I_e | A | 6 | | - |
| Rated operational current for AC-15 | I_e | A | 6 | | - |
| Electrical endurance | | cycles | 100.000 | | 1.000.000 |
| Terminal capacity | S | mm ² | | 1 ... 4 rigid / flexible | |
| Screw | | | | M3 | |
| Screw-head | | | | PZ1 | |
| Tightening torque | | Nm | | 0.8 | |

Contact arrangement for auxiliary switch BIN

BIN20

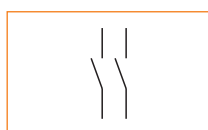

BIN11

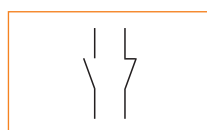

BIN1C

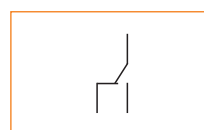

Technical details for auxiliary device for group control BIG

Maximum number of bistable switches that can be controlled:

- 230 V AC: 20
- 120 V AC: 10
- 48 V AC: 5

Technical details for compensation capacitor BIK

For operations of bistable switches without malfunctions when illuminated push-buttons are used.

Compensation capacitors parallel to the coil of bistable switch increases the power consumption of 230 V 50 Hz illuminated push-buttons from 2.5 mA to 20 mA (capacitor 2.2 F / 300 V AC)

Ordering data

| | | | |
|-------------------------|-------|-------|-------|
| Auxiliary switches: | BIN20 | BIN11 | BIN1C |
| Central control: | BIC | | |
| Group control: | BIG | | |
| Compensation capacitor: | BIK | | |



Iskra Sistemi, d. d.

Stegne 21

SI-1000 Ljubljana

Slovenia

Phone: +386 1 51 31 000

Fax: +386 1 51 11 532

www.iskrasistemi.si

info@iskrasistemi.si